



Table Of Contents

| | | | |
|--|------|--|-------|
| Pictorial Index | A-24 | Tubular Heaters for Hot Runner Manifolds | 10-13 |
| Tubular Heater Introduction and Specifications | 10-2 | Standard Sizes and Ratings | 10-14 |
| Tubular Heater Terminations | 10-4 | Finned and Single Ended Tubular Heaters..... | 10-16 |
| Tubular Heater Mounting Methods | 10-6 | Quote Request Form..... | 10-18 |
| Tubular Heater Moisture Seals | 10-8 | | |
| Typical Bend Formations | 10-9 | | |

10
section

Tubular Heaters

Tubular Heaters



Introduction

Tubular Heater Introduction

Typical Applications

- ↪ Forced air heating
- ↪ Thermal forming machines
- ↪ Direct immersion in liquids
- ↪ Comfort radiant heaters
- ↪ Welded, brazed or clamped to tanks and pipes
- ↪ Hot runner molds
- ↪ Combination radiant and convection heater for ovens and dryers

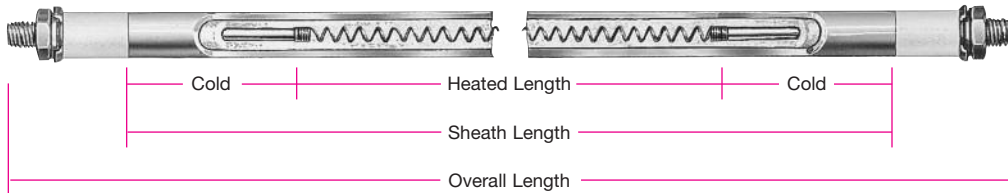

Design Guidelines

Resistance Tolerance

Tubular heating elements have an Industry Standard Resistance Tolerance of +10%, -5% which translates to a Wattage Tolerance of +5%, -10%. Consult Tempco if tighter tolerances are required for your application.

Watt Density

Element Watt Density is the wattage dissipated per square inch of the element sheath surface and is critical to the proper heating of the application and to the life expectancy of the heater. The Watt Density is calculated with the following formula:

$$\text{Watt Density (w/in}^2\text{)} = \frac{\text{Element Wattage}}{\pi \times \text{Element Dia.} \times \text{Element Heated Length}}$$

For a particular application element watt density will govern element sheath and internal resistance wire temperature. Factors to consider when choosing a suitable watt density are:

1. Many materials are heat sensitive and can decompose or be damaged if the element is running too hot.
2. Air and other gases that are poor conductors of heat require watt densities matched to the velocity of the gas flow to prevent element overheating.
3. When heating hard water or cleaning solutions, mineral deposits can build up on the element sheath, acting as a heat insulator and raising the internal element temperature. If these deposits cannot be periodically removed, use a lower watt density element to increase heater life expectancy.
4. Page 16-12 in the Engineering Data Section of this catalog lists the maximum recommended heater watt density for many materials. For additional information and help please contact Tempco.

Important Note — When heating any substance it is critical to match the heater watt density, operating temperature and sheath material to the specific medium being heated. Failure to do so will result in premature heater failure and/or unsafe conditions.



Construction Characteristics

Tempco Tubular Heaters are the most versatile and widely used source of electric heat for industrial, commercial and scientific applications. They can be designed in a wide range of electrical ratings, diameters, lengths, terminations, and sheath materials. Important and useful characteristics of tubular heaters are that they can be formed into virtually any shape, brazed or welded to any metal surface, and cast into metals. Carefully researched manufacturing methods and quality materials have made Tempco tubular heaters stand apart from other heating elements claiming similar performance.

The cutaway view shows the tubular heater's basic construction. A computer-designed helical coil of 80% Nickel 20% Chromium alloy resistance wire is fusion welded to the nickel-coated steel terminal cold pin. This coil assembly is precisely stretched and centered in the element metal sheath, which is then filled with Grade "A" Magnesium Oxide powder (MgO). The filled tube is then compacted by a roll reduction

mill into a solid mass, permanently stabilizing the coil in the center of the tube while providing excellent heat transfer and dielectric strength between the coil and the sheath.



Tubular Heating Elements being filled with MgO insulating powder.

Agency



Approvals

Tempco Tubular Heating Elements are certified as Recognized Components by Underwriters Laboratories (File Number E90771) under CCN UBJY2/8 to meet Standard UL1030. Tempco's equivalent CSA File Number is 043099.

These files specify the end use Watt Density limitations and conditions of acceptability for the use of this type heater. For additional information consult Tempco.

If you require UL, CSA, or other NRTL agency approvals, please specify when ordering.





Tubular Heater Standard Specifications

| Element Diameter | | Maximum Voltage | Maximum Amperage | Resistance in Ohms per Heated Inch | | Sheath Length | | | |
|------------------|------|-----------------|------------------|------------------------------------|-----|---------------|-----|------|------|
| in | mm | | | min | max | min. | | max. | |
| | | | | | | in | mm | in | mm |
| .260 | 6.6 | 250 | 15 | .100 | 17 | 11 | 279 | 200 | 5080 |
| .315 | 8.0 | 480 | 30 | .060 | 21 | 11 | 279 | 200 | 5080 |
| .375 | 9.5 | 600 | 30 | .040 | 21 | 11 | 279 | 200 | 5080 |
| .430 | 10.9 | 600 | 40 | .040 | 21 | 11 | 279 | 268 | 6807 |
| .475 | 12.1 | 600 | 40 | .040 | 21 | 11 | 279 | 268 | 6807 |
| .625 | 15.9 | 600 | 40 | .040 | 17 | 11 | 279 | 255 | 6477 |

Table 1 Electrical Limitations and Minimum/Maximum Sheath Lengths

| Length | | Sheath Length Tolerance (±) | | Heated Length Tolerance (±) | | Minimum Unheated Length Each End | |
|---------|-----------|-----------------------------|------|-----------------------------|----|----------------------------------|----|
| in | mm | in | mm | in | mm | in | mm |
| 11-20 | 279-508 | 3/32 | 2.4 | 1/4 | 6 | 1 | 25 |
| 20-50 | 508-1270 | 1/8 | 3.2 | 1/2 | 13 | 1-1/4 | 32 |
| 50-80 | 1270-2032 | 5/32 | 4.0 | 7/8 | 22 | 1-1/2 | 38 |
| 80-110 | 2032-2794 | 3/16 | 4.8 | 1-1/8 | 29 | 1-5/8 | 42 |
| 110-140 | 2794-3556 | 7/32 | 5.6 | 1-3/8 | 35 | 1-3/4 | 44 |
| 140-170 | 3556-4318 | 1/4 | 6.4 | 1-5/8 | 41 | 2 | 51 |
| 170-200 | 4318-5080 | 3/8 | 9.5 | 1-7/8 | 48 | 2-1/4 | 57 |
| 200-up | 5080-up | 1/2 | 12.7 | 2-3/8 | 60 | 2-1/2 | 64 |

Table 2 Sheath and Heated Length Tolerance (applicable for all diameters)

Tubular Heater Standard Sheath Materials

The selection of a sheath material should be made based on the chemical composition of the gas or liquid being heated, the characteristics of the materials entering the solution, and the processes controls. A material selection guide can be found on page 16-12.

NOTE: The best source for chemical/sheath compatibility is the supplier of the gas or liquid to be heated.

The following are the most common tubular element sheath materials. For other materials consult Tempco.

Incoloy® 840: Nickel 18-20%, Chromium 18-22%, Iron balance. Has about 10% less nickel than Incoloy 800. Used in many air heating applications, where it has exhibited superior oxidation resistance at less cost than Incoloy 800.

Maximum Sheath Temperature: 1600°F / 871°C

Incoloy® 800: Nickel 30-35%, Chromium 19-23%, Iron balance. The high nickel content of this alloy contributes to its resistance to scaling and corrosion. Used in air heating and immersion heating of potable water and other liquids.

Maximum Sheath Temperature: 1600°F / 871°C

316 Stainless Steel: Chromium 16-18%, Nickel 11-14%, Iron balance. Modified with the addition of Molybdenum (2-3%) to improve corrosion resistance in certain environments, especially those which would tend to cause pitting due to the presence of chlorides. Applications include deionized water.

Maximum Sheath Temperature: 1200°F / 649°C

304 Stainless Steel: Chromium 18-20%, Nickel 8-11%, Iron balance. Used in the food industry, medical, and chemical heating.

Maximum Sheath Temperature: 1200°F / 649°C

321 Stainless Steel: Chromium 17-20%, Nickel 9-13%, Iron balance. Modified with the addition of Titanium to prevent carbide precipitation and resulting intergranular corrosion that can take place in certain mediums when operating in the 800-1200°F (427-649°C) temperature range.

Maximum Sheath Temperature: 1200°F / 649°C

Copper: Standard Copper Alloy

A low temperature, inexpensive material used mainly for clean water heating.

Maximum Sheath Temperature: 350°F / 177°C

Steel: Low Carbon

Used for high to low viscosity oils, asphalt, tar, wax, molten salt, heat transfer liquid media and other compatible solutions.

Maximum Sheath Temperature: 750°F / 399°C

Other Sheath Materials: Available for a limited number of diameters. Consult Tempco for more information.

Inconel® 600: Iron 6-10%, Chromium 14-17%, Nickel balance

Maximum Sheath Temperature: 1800°F / 982°C

Incoloy® 825: Nickel 38-46%, Chromium 19.5-23.5%, Molybdenum 2.5-3.5%, Iron balance

Maximum Sheath Temperature: 1100°F / 593°C



Maximum Sheath Temperature refers to the maximum temperature of the element sheath material. Consideration must be given to the maximum temperature that can be safely applied to the heated material. See **Watt Density** on the previous page for additional information.



Incoloy® and Stainless Steel Element Sheath Surface Treatments

Standard Surface Finish

The standard tubular heater element surface finish is a black chrome oxide, produced when the element is annealed prior to forming in an exothermic atmosphere furnace.

Optional Surface Finishes

Bright Annealing is an option where the tubular heater is annealed in a dissociated ammonia atmosphere furnace. This produces a clean metallic appearance without surface-etching the sheath.

Electro-Polishing is an electrochemical process that removes surface imperfections and contaminants, enhancing the corrosion resisting ability of the sheath. The resulting surface is clean, smooth and has a bright finish; it is highly recommended for medical, food and other harsh applications.

Passivation removes surface contamination, usually iron, so that the optimum corrosion resistance of the stainless steel is maintained. Surface contamination could come from the small amount of steel that may be worn off a tool during the manufacturing process.

Standard Tubular Heater Terminations

Select the termination style that meets your requirements for space, accessibility and reliability.



Note: If the listed terminations do not seem to fit your requirements, call us and let us design one that will.

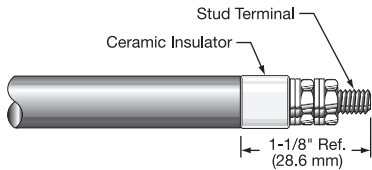

TYPE T—STANDARD

Threaded stud terminal with ceramic insulator.

| Element Diameter | | Standard Thread Size |
|------------------|------|----------------------|
| in | mm | |
| .260 | 6.6 | 6-32 |
| .315 | 8.0 | 8-32 |
| .375 | 9.5 | 8-32 |
| .430 | 10.9 | 10-32 |
| .475 | 12.0 | 10-32 |
| .625 | 15.9 | 10-32 |

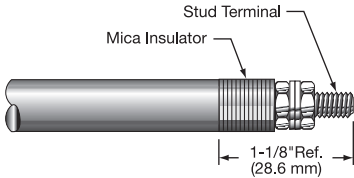

TYPE TM—Stud with Mica Insulator

Stud terminal with mica insulator.

Other thread sizes and lengths are available.



TYPE P—Plain Pin

Plain terminal pin. Specify Length "L."
Standard 1/2" (12.7 mm) pin length.

| Element Diameter | | Nominal Pin Diameter | |
|------------------|------|----------------------|-----|
| in | mm | in | mm |
| .260 | 6.6 | .091 | 2.3 |
| .315 | 8.0 | .105 | 2.7 |
| .375 | 9.5 | .105 | 2.7 |
| .430 | 10.9 | .125 | 3.2 |
| .475 | 12.0 | .125 | 3.2 |
| .625 | 15.9 | .160 | 4.1 |

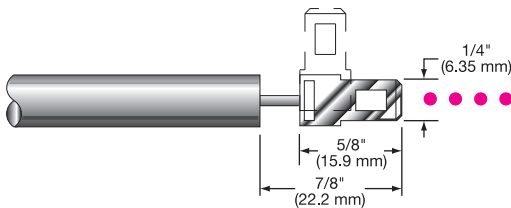

TYPE SF & SF90 (90°)—Quick Connect

1/4" male (3/16" optional) quick connect (slip-on) terminals are welded to the element terminal pin. They provide quick and easy installation of lead wire with excellent holding force. Specify if an optional mica or ceramic insulator is required. Material: Nickel-Plated Steel.

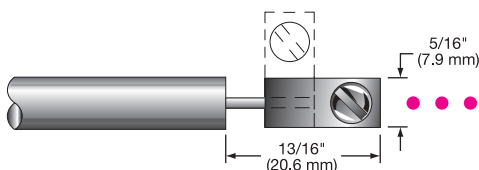

TYPE L_ & L9_ (90°)—Terminal Lug

A nickel-plated steel lug is projection welded to the terminal pin straight (Type "L_") or at 90° to the sheath (Type "L9_"). Specify if an optional mica or ceramic insulator is required.

Standard LA, L9A 10-32 screw Optional LB, L9B 8-32 screw



Tubular Heater Standard Terminations

TYPE E__ – Right-Angle Lug Terminal

- Type E1A** 8-32 screw with mica insulator (Standard)
- Type E1B** 8-32 screw with ceramic insulator
- Type E2A** 10-32 screw with mica insulator
- Type E2B** 10-32 screw with ceramic insulator

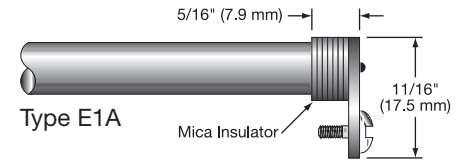

TYPE A__ – Right-Angle Terminal (for use when space is tight)

- Type A1A** 8-32 screw with mica insulator
- Type A1B** 8-32 screw with ceramic insulator
- Type A2A** 10-32 screw with mica insulator
- Type A2B** 10-32 screw with ceramic insulator (Standard)

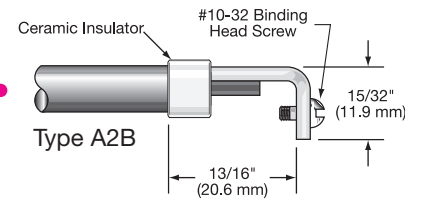

TYPE F1__ – Lead Wire

When selecting a lead wire type, consideration should be given to the maximum ambient temperature the lead wire is exposed to and the environment it is in. Lead wire options Type R1 and W1 below will provide additional environmental protection to the Type F1 lead wire selected.

- Type F1A** 250°C (482°F) TGGT insulation
- Type F1B** 450°C (842°F) MGT insulation
- Type F1C** 200°C (392°F) Teflon® insulation
- Type F1D** 150°C (302°F) Silicone Rubber insulation
- Type F1E** 105°C (221°F) Thermoplastic (PVC) insulation

Standard 10" (254 mm) leads with fiberglass sleeve. Specify if other lead length is required.

F1C F1D & F1E available with optional heat shrink sleeving. Specify when ordering if required.

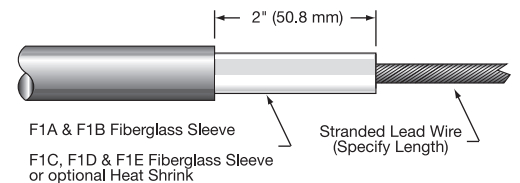

Lead wire gauge is determined by the ampacity of the heater with the lead wires in an ambient temperature of 40°C (104°F). Higher ambients may require heavier gauge lead wires.

Lead Wire Termination Options

TYPE R1__ – Flexible Armor Cable

- Type R1A** Galvanized cable
- Type R1B** Stainless steel cable

Provides excellent protection to lead wires in abrasive environments.
Standard 10" (254 mm) armor cable over 12" (305 mm) leads.
Specify if other lead and/or cable lengths are required.

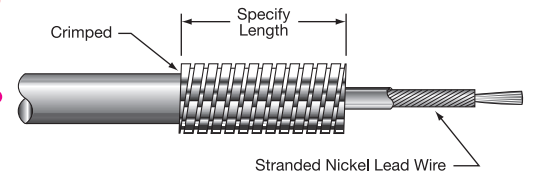

TYPE W1__ – Stainless Steel Wire Braid

Provides good protection to lead wires where flexibility is needed.
Standard 10" (254 mm) braid over 12" (305 mm) leads.
Specify if other lead and/or cable lengths are required.

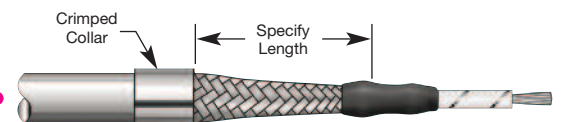



Mounting Methods

Tubular Heater Standard Mounting Methods

TYPE B – Bulkhead Fittings

Bulkhead fittings provide a leakproof method for mounting tubular heating elements through tank walls. Standard are round brass fittings crimped onto the element that are suitable for low pressure water (up to 80 psig) and non-pressure air. A brass hex nut, plated steel washer and gasket are supplied as standard.

Fittings for vacuum or high pressure gas and liquid use are silver brazed or TIG welded. Method will vary by material and application. Fittings in table are most commonly used. Special fittings can be made to meet your application requirements.

Standard fitting location is with threads flush at the end of the element sheath as shown below. For other locations specify distance from end of sheath.

CAUTION Do not locate the fitting over the heated section of the element.

Specify: Material; Round (Standard) or Hex Flange; Thread Type and Length; Location on Sheath; Crimped, Brazed, or Welded Construction.

Fitting Attachment Method — General Guidelines

These are guidelines only. Consult Tempco if you require assistance in determining the method best suited to your application.

Fittings Crimped: Low pressure water (up to 80 psig) and non-pressure air applications

Fittings Brazed: Non-ferrous alloys (copper) and dissimilar non-weldable metals

Fittings Welded: High pressure liquids and gases, and high temperature applications

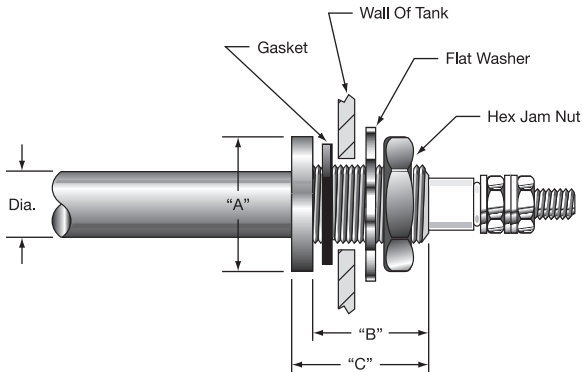

Standard Bulkhead Fittings For Tubular Heaters — Round Flanged Standard

| Tubular Diameter | | Fitting Material | Flange Type | "A" | | "B" | | "C" | | Thread Size (UNF) |
|------------------|------|------------------|--------------|-------|----|-----|------|-----|----|-------------------|
| in | mm | | | in | mm | in | mm | in | mm | |
| .260 | 6.6 | Brass | Round | 3/4 | 19 | 1/2 | 12.7 | 5/8 | 16 | 1/2-20 |
| .260 | 6.6 | Stn. Stl. | Round | 3/4 | 19 | 1/2 | 12.7 | 5/8 | 16 | 1/2-20 |
| .315 | 8.0 | Brass | Round | 3/4 | 19 | 1/2 | 12.7 | 5/8 | 16 | 1/2-20 |
| .315 | 8.0 | Stn. Stl. | Round | 3/4 | 19 | 1/2 | 12.7 | 5/8 | 16 | 1/2-20 |
| .375 | 9.5 | Brass | Round | 3/4 | 19 | 1/2 | 12.7 | 5/8 | 16 | 1/2-20 |
| .375 | 9.5 | Stn. Stl. | Round | 3/4 | 19 | 1/2 | 12.7 | 5/8 | 16 | 1/2-20 |
| .430 | 10.9 | Brass | Round or Hex | 7/8 | 22 | 3/4 | 19.0 | 7/8 | 22 | 5/8-18 |
| .430 | 10.9 | Stn. Stl. | Round or Hex | 7/8 | 22 | 3/4 | 19.0 | 7/8 | 22 | 5/8-18 |
| .430 | 10.9 | Steel | Round | 7/8 | 22 | 3/4 | 19.0 | 7/8 | 22 | 5/8-18 |
| .475 | 12.1 | Brass | Round | 7/8 | 22 | 3/4 | 19.0 | 7/8 | 22 | 5/8-18 |
| .475 | 12.1 | Stn. Stl. | Round | 7/8 | 22 | 3/4 | 19.0 | 7/8 | 22 | 5/8-18 |
| .475 | 12.1 | Steel | Round | 7/8 | 22 | 3/4 | 19.0 | 7/8 | 22 | 5/8-18 |
| .475 | 12.1 | Brass | Round | 1 | 25 | 3/4 | 19.0 | 7/8 | 22 | 3/4-16 |
| .475 | 12.1 | Stn. Stl. | Round | 1 | 25 | 3/4 | 19.0 | 7/8 | 22 | 3/4-16 |
| .625 | 15.9 | Stn. Stl. | Round | 1-1/8 | 29 | 3/4 | 19.0 | 1 | 25 | 7/8-14 |



Note: Optional Larger Thread Sizes and Hex Flanged Bulkhead Fittings are available. Consult Tempco with your requirements.



Tubular Heater Standard Mounting Methods

| Part Number | For Element Diameter | | "A" Thick | | "B" OD | |
|-------------|----------------------|------|-----------|------|--------|------|
| | in | mm | in | mm | in | mm |
| FAS-108-102 | .260 | 6.6 | 5/16 | 7.9 | 5/8 | 15.9 |
| FAS-108-102 | .315 | 8.0 | 5/16 | 7.9 | 5/8 | 15.9 |
| FAS-108-103 | .375 | 9.5 | 3/8 | 9.5 | 3/4 | 19.1 |
| FAS-108-104 | .430 | 10.9 | 7/16 | 11.1 | 7/8 | 22.2 |
| FAS-108-106 | .475 | 12.0 | 7/16 | 11.1 | 1 | 25.4 |

TYPE MC – Mounting Collar

Plated steel mounting collars are locked in place with a set-screw and serve as an adjustable stop for through-the-wall mounting. Collars are shipped in bulk unless otherwise specified. Mounting collars can be ordered with the heater or purchased separately.

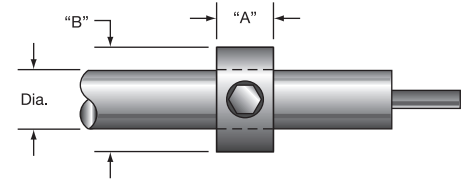

TYPE LR – Locator Washer

Locator washers are permanently attached to the heater sheath by staking/crimping and are used to limit the movement of the heater while allowing for expansion and contraction of the heater sheath. When ordering, specify location from end of sheath.

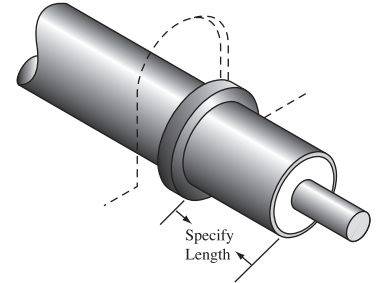

Multiple element heater assembly with a custom mounting bracket.



TYPE MF – Mounting Bracket

Tempco's made-to-order mounting brackets are made from 18 gauge stainless steel for strength and stiffness. It is an economical way to mount the heater in non-pressurizing, non-liquid applications. Unless otherwise specified, the bracket will be located 1/2" from the edge of the heater sheath. OEM quantity brackets are manufactured by Tempco on our own high speed precision N/C Turret Press. The standard method of attaching the tubular element to the bracket is staking or crimping.

The rectangular mounting bracket shown at right is a popular made-to-order design. Specify all dimensions shown when requesting a quote.

Custom brackets of any size, thickness or material can be supplied to meet your requirements.

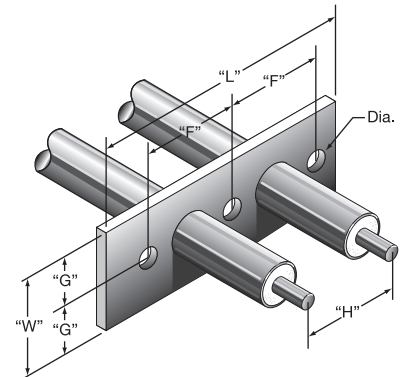



Moisture Seals

Tubular Heater Standard Moisture Seals

Magnesium Oxide (MgO) is used as the insulating material in Tempco tubular heaters because of its excellent thermal conductivity and dielectric strength. However, MgO is hygroscopic and can absorb moisture from the atmosphere. This absorption of moisture may be detected when an Insulation Resistance (IR) test is done with a megohmmeter prior to energizing the heater circuit. In very humid environments, circuits utilizing a GFI (ground fault interrupter) for safety may experience nuisance tripping when energizing the heater.

The Tempco manufacturing process produces a dry element with an IR of several thousand megohms minimum. However, after shipment and depending on humidity levels and storage time, a heater can absorb moisture and show a decrease in IR. In many cases, depending on the supply voltage and the application, the heater can be safely energized and will dry itself out.

If a heater has absorbed moisture, a safe and effective method of drying it out prior to installation is to bake it in an oven at 300°F (149°C) until an acceptable IR reading is obtained. When possible, removing the terminal hardware will expedite this process. If this method is not practical consult factory for other recommendations.

For applications where moisture absorption would be unacceptable Tempco has several optional element end seals to retard absorption of moisture in the MgO. If a true hermetic seal is required, ceramic to metal end seals (Type H) are available. With any of these seals, the maximum recommended termination temperature in the seal area must not be exceeded.

Style SS—Silicone Resin Seal

A brushed-on coating that penetrates the MgO, offering economical moisture protection under humid storage conditions.

Maximum Usable Termination Temperature: 390°F (200°C)

UL Rated Maximum Termination Temperature: 221°F (105°C)

Type V2A: conformal coating

Type V2B: silicone oil

Style SER—RTV Seal

RTV (room temperature vulcanizing) silicone rubber adhesive sealant provides a good moisture seal.

UL Rated – Maximum Termination Temperature:

Type R: 302°F (150°C)

Type R1: 392°F (200°C)

Style SEH—Epoxy Resin Seal

Epoxy resin provides a moisture resisting barrier.

UL Rated – Maximum Termination Temperature:

Type V: 194°F (90°C)

Type V1: 266°F (130°C)

Type V4: 392°F (200°C)

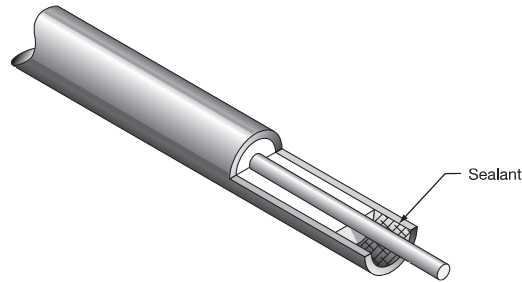

TYPE M—Self Sealing Heat Shrinkable Boot with Lead Wire

This type seal is used primarily for defrost heaters.

Temperature range -67 to 300°F (-55 to 149°C).

Standard 10" (254 mm) leads;
specify longer leads if required.

| Heater Diameter | | "A" | | "B" | |
|-----------------|------|-------|----|------|----|
| in | mm | in | mm | in | mm |
| .260 | 6.6 | 2-1/8 | 54 | 7/16 | 11 |
| .315 | 8.0 | 2-1/8 | 54 | 7/16 | 11 |
| .430 | 10.9 | 2-1/8 | 54 | 9/16 | 14 |

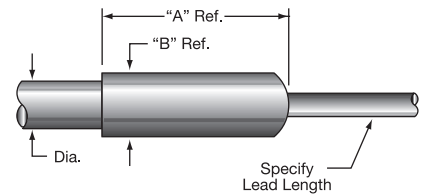

TYPE H—Hermetic Seal

Ceramic to metal seals provide an airtight seal for temperatures to 500°F (260°C) in the seal area.

| Heater Diameter | | "A" | | "B" | | Thread Size |
|-----------------|------|---------|----|-------|----|-------------|
| in | mm | in | mm | in | mm | |
| .260 | 6.6 | 1-11/16 | 43 | 13/32 | 10 | 8-32 |
| .315 | 8.0 | 1-11/16 | 43 | 13/32 | 10 | 10-32 |
| .430 | 10.9 | 2-1/8 | 54 | 21/32 | 17 | 1/4-28 |
| .475 | 12.1 | 2-1/8 | 54 | 21/32 | 17 | 1/4-28 |

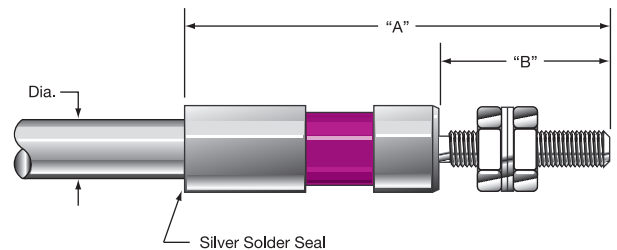



Tubular Heater Standard Bend Formations

Forming Tubular Elements

The MgO insulation used in tubular heating elements is compacted by reducing the element diameter in a roll reducing mill. The elements are then annealed in a controlled atmosphere furnace to relieve the metal stressing (work hardening) that takes place during the rolling to size reduction of the sheath. Annealing brings the metal back to a soft state, allowing the element to be bent into virtually any configuration. However, since forming also work hardens the metal, some precautions must be observed in order to prevent the sheath from breaking during bending or developing stress cracking marks.



Note: Elements with tight bends and some applications require the bends to be recompacted in special dies to restore the integrity of the insulation density and maintain dielectric strength. Large bends do not need to be recompacted.

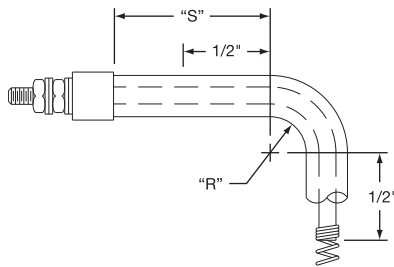

Avoid bends within a minimum of 1/2" of the terminal pin and resistance wire junctions unless the bending radius is a minimum 3" (75 mm).

Elements are being fed into a roll reducing mill to compact the MgO insulating powder. After rolling, the elements are annealed in the conveyor belt furnace seen in the background.



Note: Smaller inside bending radius than listed in the table can be factory accomplished. It requires special forming techniques to prevent damage to the tubular heater. Consult Tempco with your requirements.

Tubular Element Minimum Bending Radius

| Element Diameter | | Factory Bend Minimum R | | Field Bend Minimum R | | Minimum S | |
|------------------|------|------------------------|------|----------------------|------|-----------|------|
| in | mm | in | mm | in | mm | in | mm |
| .260 | 6.6 | 3/8 | 9.5 | 3/4 | 19.1 | 1/2 | 12.7 |
| .315 | 8.0 | 1/2 | 12.7 | 1 | 25.4 | 1/2 | 12.7 |
| .375 | 9.5 | 9/16 | 14.3 | 2 | 50.8 | 5/8 | 15.9 |
| .430 | 10.9 | 3/4 | 19.1 | 2-1/2 | 63.5 | 3/4 | 19.1 |
| .475 | 12.0 | 7/8 | 22.2 | 2-1/2 | 63.5 | 1 | 25.4 |

TYPICAL Bend Formations

We do custom formations. Contact Tempco with your requirements.

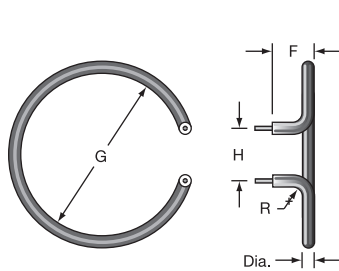

FT1

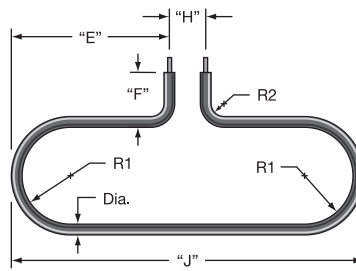

FT2

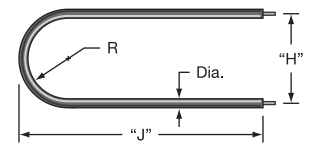

FT3

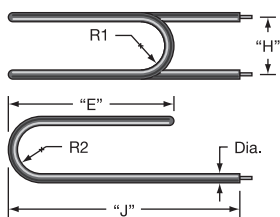

FT4

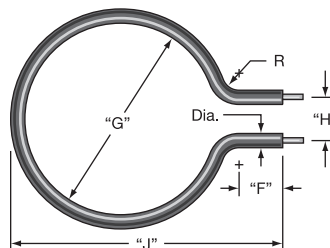

FT5

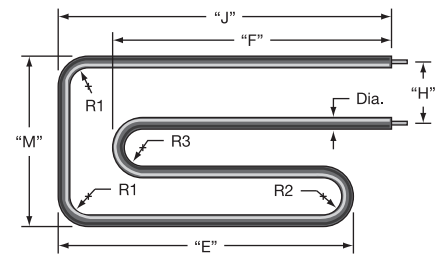

FT6



Tubular Heater Standard Bend Formations

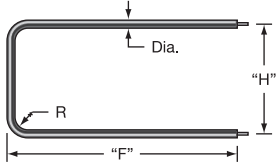

FT7

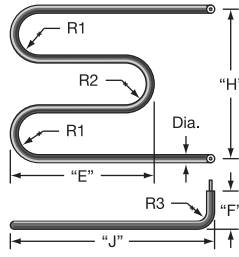

FT8

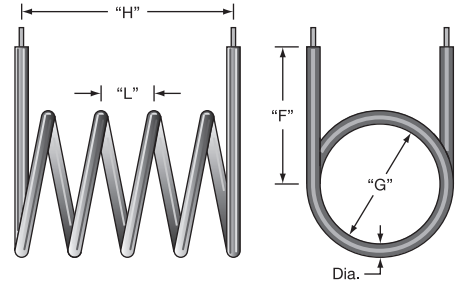

FT9

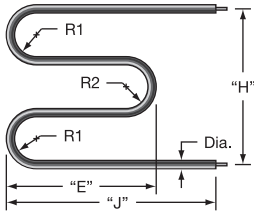

FT10

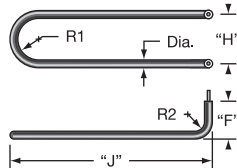

FT11

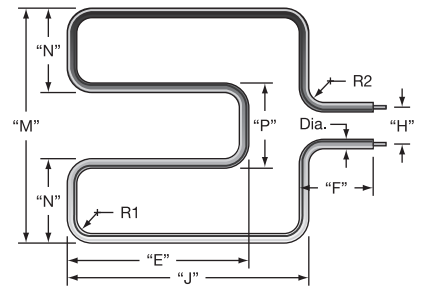

FT12

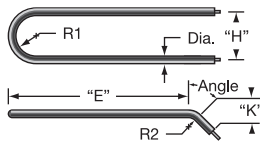

FT13

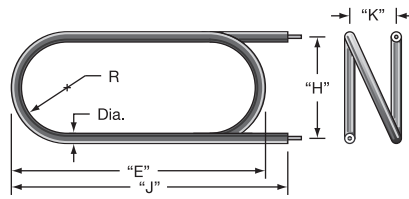

FT14

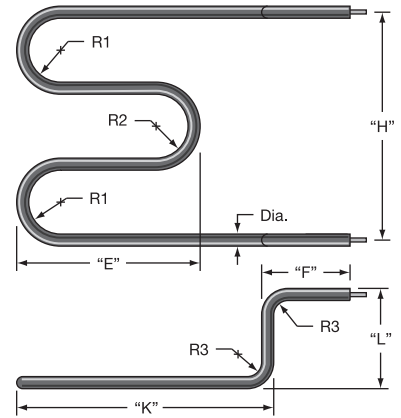

FT15

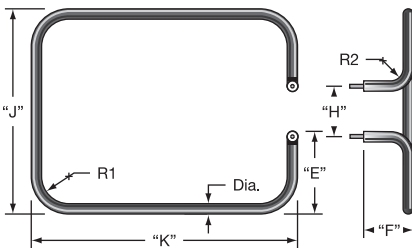

FT16

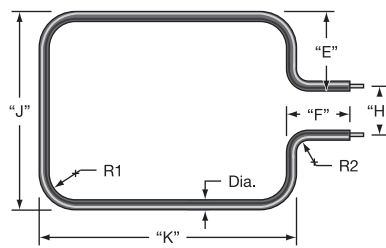

FT17

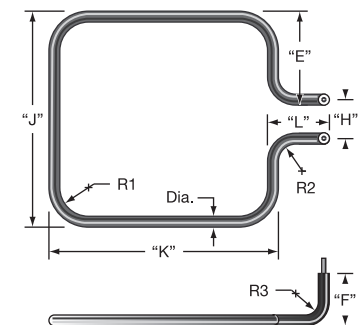

FT18



Tubular Heater Standard Bend Formations

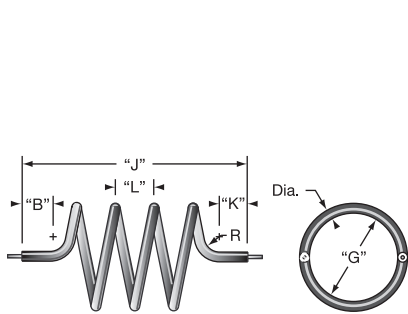

FT19

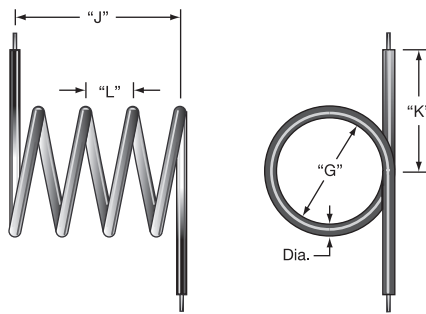

FT20

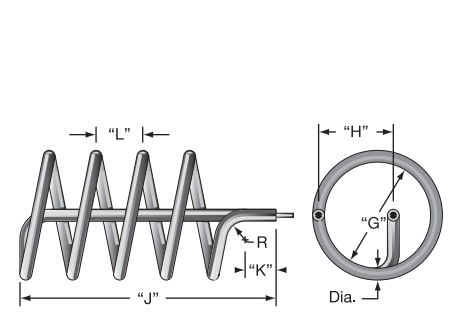

FT21

TYPICAL Bend Formations

We do custom formations.
Contact Tempco with
your requirements.

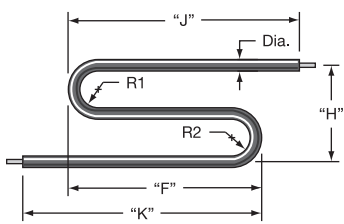

FT22

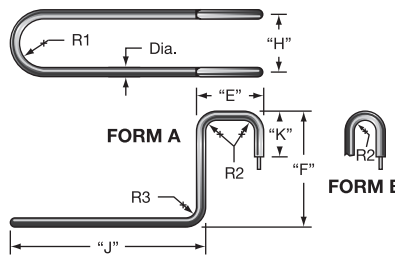

FT23

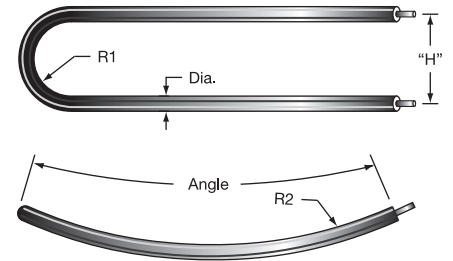

FT24

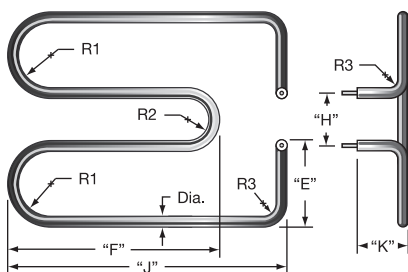

FT25

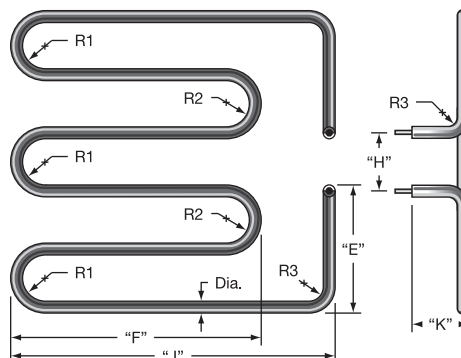

FT26

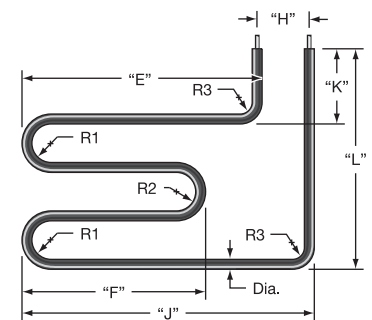

FT27

Bend Formations

Tubular Heater Standard Bend Formations

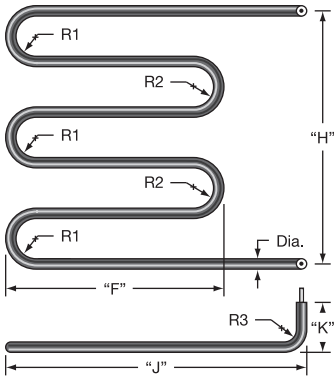

FT28

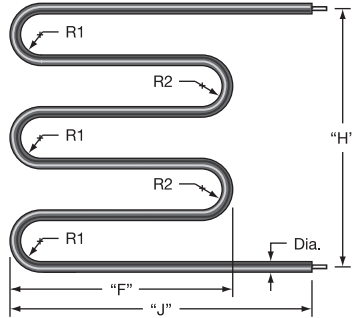

FT29

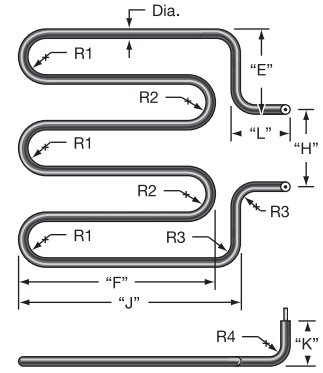

FT30

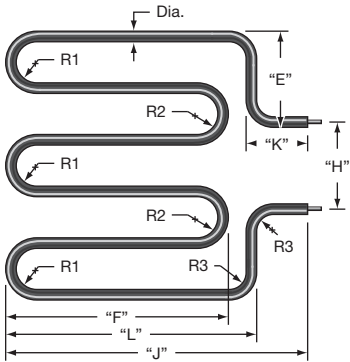

FT31

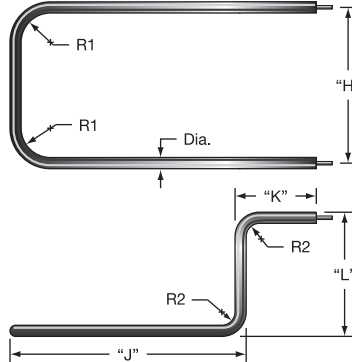

FT32

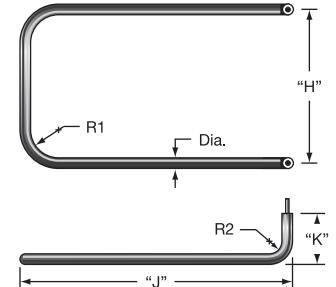

FT33

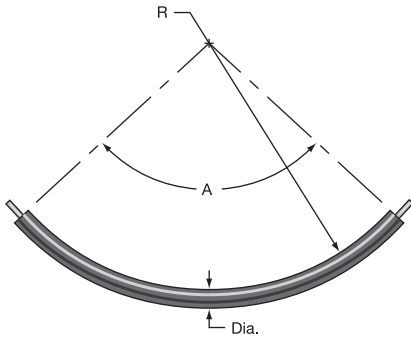

FT34

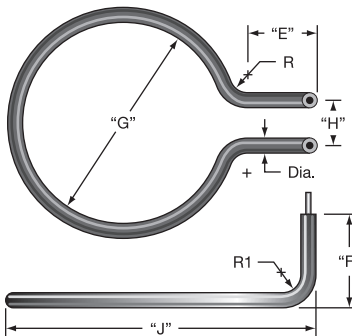

FT36

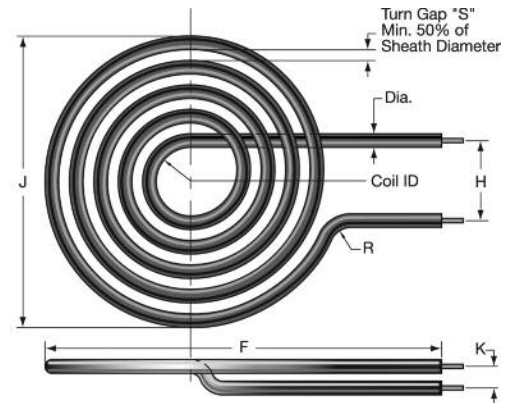

FT37

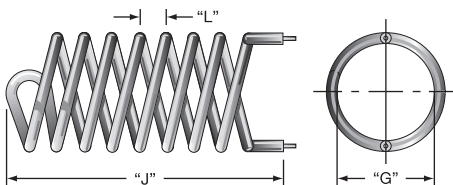

FT35



Tubular Heaters for Hot Runner Manifolds



Construction

Hot Runner Manifold Heaters are made to order using .260", .315" or .375" diameter Incoloy® tubular heating elements. Commonly specified terminations include threaded stud or wire leads.

Important Information on Forming

Precise forming of the tubular heater is required for it to seat properly into the milled slot in the manifold. To ensure this fit, we use a physical template as an inspection tool in the forming process to verify bending accuracy.

The template is a reproduction of the milled slot in the form of a plastic or aluminum plate. It can be customer supplied or manufactured by Tempco. Only through the use of a forming template is bending accuracy guaranteed.

When ordering for new applications:

Supply a drawing or forming template if available.

When ordering for replacement:

Supply a sample heater and/or a drawing of the manifold indicating the milled heater slot.



Note: For heaters originally manufactured by Tempco only the Tempco Part Number is required.

Examples of Mold Heater Formations

*Consult Tempco With Your Requirements.
We Welcome Your Inquiries.*

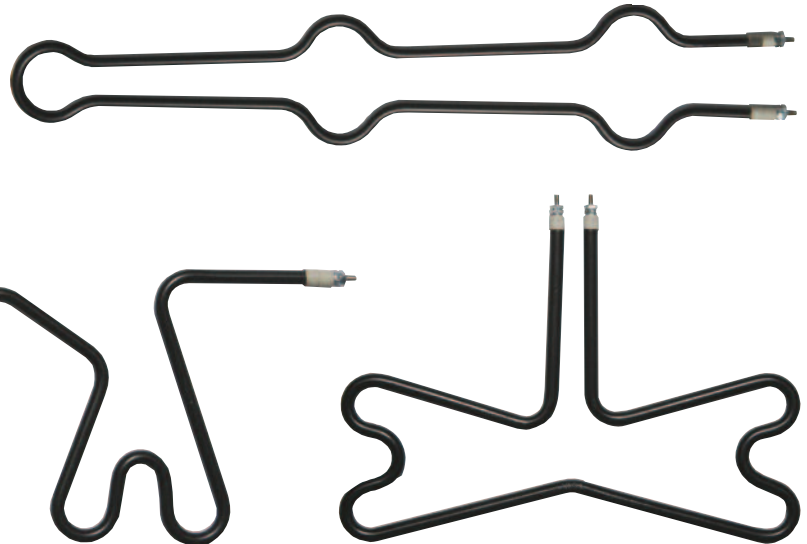

Heat Transfer Cement

When tubular heating elements are used in a milled slot any air gaps between the element and the plate can cause hot spots on the element. Heat transfer cement is used to fill these air gaps, permitting the heater to run cooler, thus maximizing its life expectancy. Cement is water soluble and can be applied with a putty knife or trowel and can be used in temperatures up to 1250°F (675°C).

Part Number SEA-108-101 (1 Gallon)
SEA-108-102 (1 Quart)

Ordering Information

TEMPCO will design and manufacture a Tubular Hot Runner Manifold Heater to meet your requirements.

Please Specify the following:

- Wattage and Voltage
- Diameter
- Heated Length
- Unheated Length at each end
- Termination Type (see pages 10-4 and 10-5)
- Supply a Drawing or Template

Tubular Heaters



Standard Sizes and Ratings

Tubular Heater Standard (Non-Stock) and Stock Sizes and Ratings

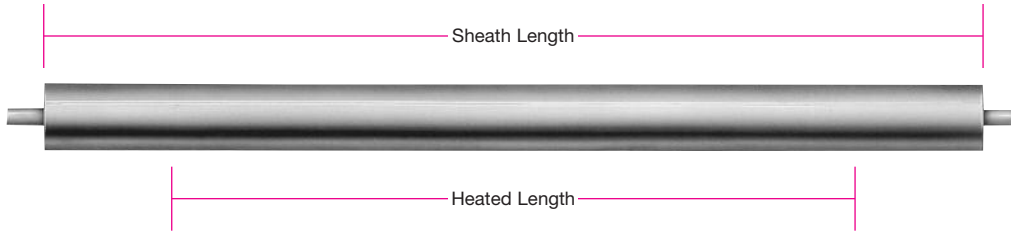

Standard tubular heaters are fully annealed for field or factory bending. They are inventoried with plain pin extensions that allow quick installation of Termination Types T, TM, F1, A, E, SF, SF9, L and L9. Part Numbers listed are for heaters with Type "T" termination. For other terminations a Part Number will be issued at time of order.

Standard (Non-Stock) and Stock Sizes and Ratings with Type T Termination

Stock Items Are Shown In **RED**

| Element Description | Sheath Length | | Heated Length | | Watts | Part Number 240V | Approximate Net Weight | |
|---|---------------|------|---------------|------|----------|------------------|------------------------|-----|
| | in | mm | in | mm | | | lbs | kgs |
| 23 W/in² .475 Dia. Incoloy® 840 12 mm (3.6 W/cm ²) | 39 | 991 | 27 | 686 | 1000 | THE04000 | 1.0 | .5 |
| | 54 | 1372 | 42 | 1067 | 1500 | THE04001 | 1.1 | .5 |
| | 69 | 1753 | 57 | 1448 | 2000 | THE04002 | 1.3 | .6 |
| | 84 | 2134 | 72 | 1829 | 2500 | THE04003 | 1.4 | .6 |
| | 99 | 2515 | 87 | 2210 | 3000 | THE04004 | 1.6 | .7 |
| | 132 | 3353 | 120 | 3048 | 4175 | THE04005 | 1.7 | .8 |
| 30 W/in² .260 Dia. Incoloy® 840 6.6 mm (4.7 W/cm ²) | 157 | 3988 | 145 | 3683 | 5000 | THE04006 | 1.8 | .8 |
| | 20 | 508 | 15 | 381 | 400 | THE04007 | .2 | .1 |
| | 25 | 635 | 20 | 508 | 500 | THE04008 | .2 | .1 |
| | 30 | 762 | 25 | 635 | 600 | THE04009 | .2 | .1 |
| | 35 | 889 | 30 | 762 | 800 | THE03384 | .3 | .1 |
| | 40 | 1016 | 35 | 889 | 900 | THE04010 | .3 | .1 |
| | 45 | 1143 | 40 | 1016 | 1000 | THE04011 | .4 | .2 |
| | 50 | 1270 | 45 | 1143 | 1200 | THE04012 | .4 | .2 |
| | 55 | 1397 | 50 | 1270 | 1200 | THE03383 | .4 | .2 |
| | 60 | 1524 | 55 | 1397 | 1400 | THE03373 | .5 | .2 |
| | 65 | 1651 | 60 | 1524 | 1600 | THE02648 | .5 | .2 |
| | 70 | 1778 | 65 | 1651 | 1800 | THE04013 | .6 | .3 |
| 75 | 1905 | 70 | 1778 | 1800 | THE04014 | .6 | .3 | |
| 80 | 2032 | 75 | 1905 | 2000 | THE04015 | .6 | .3 | |
| 30 W/in² .315 Dia. Incoloy® 840 8.0 mm (4.7 W/cm ²) | 15 | 381 | 10 | 254 | 300 | THE04016 | .2 | .1 |
| | 20 | 508 | 15 | 381 | 400 | THE04017 | .3 | .1 |
| | 25 | 635 | 20 | 508 | 600 | THE04018 | .3 | .1 |
| | 30 | 762 | 25 | 635 | 800 | THE04019 | .4 | .2 |
| | 35 | 889 | 30 | 762 | 900 | THE03328 | .5 | .2 |
| | 40 | 1016 | 35 | 889 | 1000 | THE04020 | .5 | .2 |
| | 45 | 1143 | 40 | 1016 | 1200 | THE04021 | .6 | .3 |
| | 50 | 1270 | 45 | 1143 | 1400 | THE04022 | .7 | .3 |
| | 55 | 1397 | 50 | 1270 | 1600 | THE04023 | .7 | .3 |
| | 60 | 1524 | 55 | 1397 | 1800 | THE03134 | .8 | .4 |
| | 65 | 1651 | 60 | 1524 | 1800 | THE04024 | .9 | .4 |
| | 70 | 1778 | 65 | 1651 | 2000 | THE03380 | 1.0 | .5 |
| | 75 | 1905 | 70 | 1778 | 2200 | THE04025 | 1.0 | .5 |
| 80 | 2032 | 75 | 1905 | 2400 | THE04026 | 1.1 | .5 | |
| 90 | 2286 | 85 | 2159 | 2600 | THE04027 | 1.2 | .5 | |
| 100 | 2504 | 95 | 2413 | 3000 | THE04028 | 1.3 | .6 | |



Tubular Heater Standard (Non-Stock) and Stock Sizes and Ratings

Standard (Non-Stock) and Stock Sizes and Ratings with Type T Termination

Stock Items Are Shown In **RED**

| Element Description | Sheath Length | | Heated Length | | Watts | Part Number 240V | Approximate Net Weight | |
|--|---------------------------------|---------------------------------|---------------------------------|------|-----------------|------------------|------------------------|-----|
| | in | mm | in | mm | | | lbs | kgs |
| 30 W/in² .430 Dia. Incoloy® 840 10.9 mm (4.7 W/cm ²) | 15 | 381 | 10 | 254 | 400 | THE04029 | .3 | .1 |
| | 20 | 508 | 15 | 381 | 600 | THE04030 | .5 | .2 |
| | 25 | 635 | 20 | 508 | 800 | THE04031 | .6 | .3 |
| | 30 | 762 | 25 | 635 | 1000 | THE04032 | .7 | .3 |
| | 35 | 889 | 30 | 762 | 1200 | THE04033 | .8 | .4 |
| | 40 | 1016 | 35 | 889 | 1400 | THE04034 | .9 | .4 |
| | 45 | 1143 | 40 | 1016 | 1600 | THE04035 | 1.0 | .5 |
| | 50 | 1270 | 45 | 1143 | 1800 | THE04036 | 1.1 | .5 |
| | 55 | 1397 | 50 | 1270 | 2000 | THE03415 | 1.3 | .6 |
| | 60 | 1524 | 55 | 1397 | 2200 | THE03376 | 1.4 | .6 |
| | 65 | 1651 | 60 | 1524 | 2400 | THE04037 | 1.5 | .7 |
| | 70 | 1778 | 65 | 1651 | 2600 | THE04038 | 1.6 | .7 |
| | 75 | 1905 | 70 | 1778 | 2800 | THE04039 | 1.7 | .8 |
| | 80 | 2032 | 75 | 1905 | 3000 | THE04040 | 1.8 | .8 |
| | 90 | 2286 | 85 | 2159 | 3500 | THE04041 | 2.0 | .9 |
| 100 | 2540 | 95 | 2413 | 4000 | THE03593 | 2.3 | 1.0 | |
| 110 | 2794 | 105 | 2667 | 4500 | THE03067 | 2.5 | 1.1 | |
| 120 | 3048 | 115 | 2921 | 5000 | THE04042 | 2.7 | 1.2 | |
| 40 W/in² .375 Dia. Incoloy® 840 9.5 mm (6.2 W/cm ²) | 21 ¹ / ₁₆ | 535 | 16 ¹ / ₁₆ | 427 | 800 | THE04043 | .4 | .2 |
| | 27 ¹ / ₈ | 689 | 22 ¹ / ₈ | 581 | 1100 | THE04044 | .5 | .2 |
| | 32 ¹ / ₈ | 816 | 27 ¹ / ₈ | 708 | 1300 | THE04045 | .6 | .3 |
| | 42 ¹ / ₈ | 1089 | 38 ¹ / ₈ | 981 | 1800 | THE04046 | .8 | .4 |
| | 57 ¹ / ₂ | 1461 | 53 ¹ / ₄ | 1353 | 2500 | THE04047 | 1.1 | .5 |
| | 69 ¹ / ₄ | 1759 | 65 | 1651 | 3000 | THE04048 | 1.3 | .6 |
| | 81 ¹ / ₄ | 2064 | 77 | 1956 | 3600 | THE04049 | 1.5 | .7 |
| | 109 ¹ / ₄ | 2775 | 105 | 2667 | 4000 | THE04050 | 2.1 | 1.0 |
| | 134 ¹ / ₂ | 3416 | 127 ³ / ₄ | 3245 | 5000 | THE04051 | 2.5 | 1.1 |
| 153 ³ / ₈ | 3896 | 145 ⁵ / ₈ | 3705 | 5500 | THE04052 | 2.9 | 1.3 | |
| 179 ¹ / ₄ | 4553 | 171 ¹ / ₄ | 4350 | 6500 | THE04053 | 3.4 | 1.5 | |
| 48 W/in² .475 Dia. Incoloy® 840 12 mm (7.4 W/cm ²) | 23 | 584 | 14 | 356 | 1000 | THE04054 | .6 | .3 |
| | 30 | 762 | 21 | 533 | 1500 | THE04055 | .9 | .4 |
| | 39 | 991 | 27 | 686 | 2000 | THE04056 | 1.1 | .5 |
| | 44 | 1118 | 35 | 889 | 2500 | THE04057 | 1.3 | .6 |
| | 54 | 1372 | 42 | 1067 | 3000 | THE04058 | 1.6 | .7 |
| | 69 | 1753 | 57 | 1448 | 4000 | THE04059 | 2.0 | .9 |
| | 84 | 2134 | 72 | 1829 | 5000 | THE04060 | 2.2 | 1.0 |
| | 99 | 2515 | 87 | 2210 | 6000 | THE04061 | 2.8 | 1.3 |
| | 149 | 3785 | 133 | 3378 | 9720 | THE04062 | 4.0 | 1.8 |

Ordering Information

Catalog Heaters

Part Numbers in **RED** are in stock for immediate delivery with Type T termination.

Termination Types TM, F1, A, E, SF, SF9, L, and L9 can be applied to stock heaters. For these terminations the Heater Part Number will be issued at time of order.

Non-Stock Part Numbers are standard designs that are available straight in 2 weeks and formed in 4 weeks.

Custom Engineered/Manufactured Heaters

An electric heater can be very application specific; for sizes and ratings not listed, **TEMPCO** will design and manufacture a tubular heater to meet your requirements. **Standard lead time is 4 weeks.**

Please Specify the following:

- | | |
|--|---|
| <input type="checkbox"/> Type of Application | <input type="checkbox"/> Sheath Material |
| <input type="checkbox"/> Wattage and Voltage | <input type="checkbox"/> Termination Type |
| <input type="checkbox"/> Diameter | <input type="checkbox"/> Type of Mounting, if Required |
| <input type="checkbox"/> Heated Length | <input type="checkbox"/> Type of Moisture Seal, if Required |
| <input type="checkbox"/> Unheated Length at Each End | <input type="checkbox"/> Bending Configuration (supply Drawing and/or Sample) |

Tubular Heaters



Finned Tubular Heaters

Finned Tubular Heaters

Tempco finned tubular heaters provide rapid heat transfer for natural convection or forced air space heating in industrial process air heating systems.

Finned tubular heaters start out as a standard tubular heater with the fins being attached on a custom built finning machine.

Standard Sizes and Materials

304 Stainless Steel .475" diameter tubular element with 1.12" diameter fin.
Copper Clad Steel .430" diameter tubular element with 1.31" diameter fin.

Other materials available for the element sheath and fins include Monel, 316 Stainless Steel and Steel with high temperature aluminum paint.

Specifications

Diameter: .315", .430", .475"

Material: 304SS, 316SS, Steel Copper Clad, Monel, Steel

Min. Sheath Length: 11"

Max. Sheath Length: 256"

Fin Diameter: 1.31", 1.14", 1.12", 0.84"

Terminations: All Tubular Heater

Max. Volts: 480 Vac

Max. Amperage: 40 Amp

Shown with optional bulkhead fittings

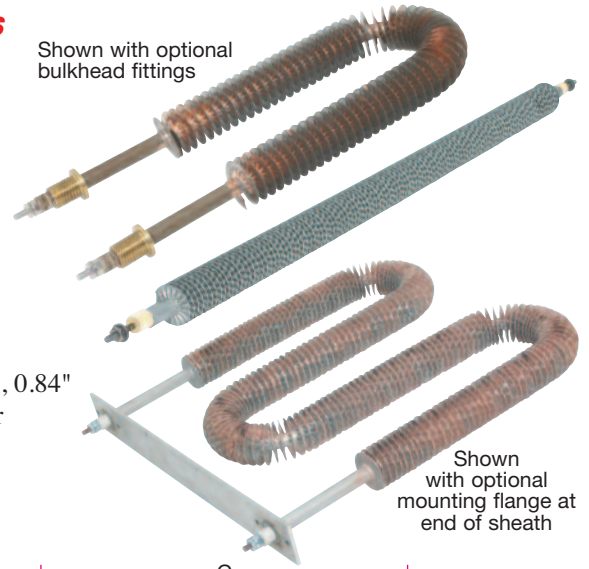

Shown with optional mounting flange at end of sheath

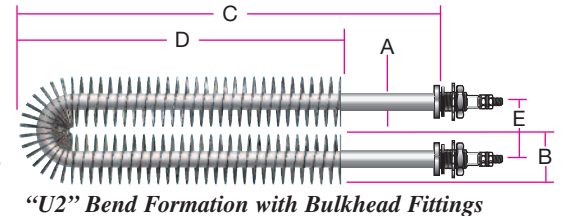
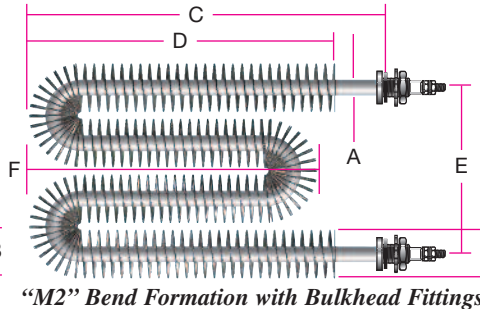
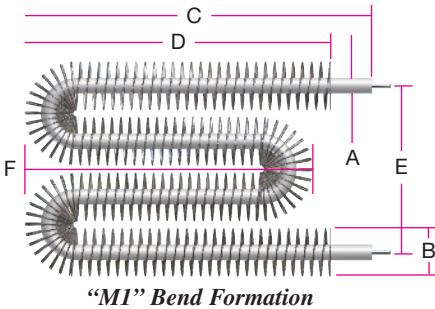
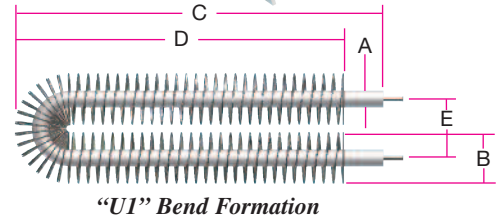
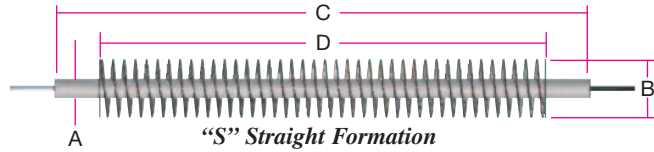

Ordering Information, Finned Tubular Heaters

Please Specify the following:

- Terminations and Seals
- Sheath Diameter
- Sheath/Fin Material
- Bend Formations and Dimensions
- Wattage and Voltage
- Bulkhead Fittings
- Mounting Flange

Single-Ended Tubular Heaters



The Single-Ended Tubular Heater manufacturing and design process is similar to that of the double ended tubular heater. Single ended tubular heaters are made strictly per customer request, providing an economical alternative to cartridge heater applications, simplifying wiring and installation for applications requiring localized heat. Flanges, bulkhead and NPT fittings can be attached to the sheath for mounting or immersion heating applications.

Specifications

Diameters: .315" .430" .475".490", .625"

Material: 304SS, 316SS, Monel, Steel

Min. Sheath Length: 11"

Max. Sheath Length: 96"

Termination: Lead Wires

Max. Volts: 277 Vac

Max. Amperage: 30 Amp

Ordering Information Single-Ended Tubular Heaters

Please Specify the following:

- Sheath Material and Diameter
- Heater Length and Cold Ends
- Bulkhead Fittings
- Wattage and Voltage
- Terminations and Seals
- Mounting Flange



The Tubular Heater — The Most Customizable Electric Heating Element



Type ART Tubular Radiant Heater Arrays



Tempco can design and manufacture a custom tubular heater array for applications requiring infrared heat. Call for details.

Other type infrared heaters can be found in Section 7.

Tubular Heaters



Quote Request

Tubular Heater, Finned Tubular Heater and Single Ended Tubular Heater Quote Request

Made-To-Order Quote Request Form — Copy and Fax (630-350-0232) us your requirements.

| | |
|--|------------------|
| | Customer Drawing |
|--|------------------|

Name _____
Company _____
Address _____

Phone _____ Fax _____
Email _____

Application Information

Describe in Detail _____

Air or Immersion _____
Maximum Load Temperature _____
Quantity _____

Specifications

Type: Standard _____ Finned _____ Single Ended _____
Sheath Material _____
Diameter _____ Fin Dia. if applies _____
Overall Sheath Length _____
Cold Section: 1st end _____ 2nd end _____
Watts _____ Volts _____
UL _____ cUL _____ CSA _____ CE _____
Termination Type _____ (Type T – standard screw)

Standard Options

Mounting: MC ___ LR ___ Location: _____ MF ___
Bulkhead Fittings ___ Material ___ Flange Type ___
Describe if Custom _____

Moisture Seals

Moisture Seals: None _____
Optional: Style SS: Type V2A _____ Type V2B _____
Style SER: Type R _____ Type R1 _____
Style SEH: Type V _____ Type V1 _____
Type M _____ Type H _____
Describe if Custom _____

Optional Sheath Surface Treatments

(For Incoloy® and Stainless Steel Sheath Elements only)
Passivation _____ Bright Annealing _____
Electro-Polishing _____
Other _____

Bends and Shapes

Standard Formation Code _____
Specify Letters and Corresponding Dimensions Below:

Number of Bends if known
Single/Multiple _____ Plane _____
Coils/Turns _____ Dia. _____
Circle: Full ___ Dia. ___ Partial ___ Degree ___
Describe if Custom: _____

